

GL55 Series Photoresistor

Photoresistor is a resistor which made of semi-conductor material, and the conductance changes with luminance variation. The photoresistor can be manufactured with different figures and illuminated area based on this characteristic. Photoresistor is widely used in many industries, such as toys, lamps, camera, etc.

Schematic Drawing

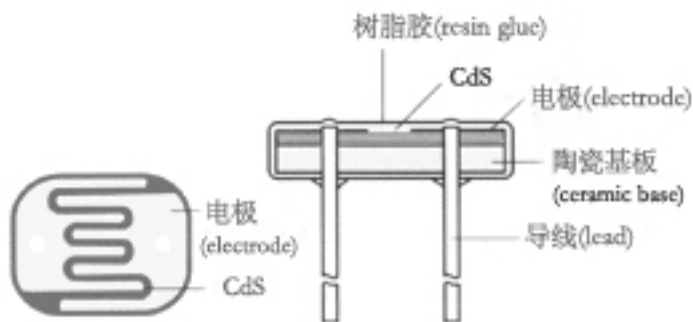

Performances and Features

- Coated with epoxy
- Small volume
- Fast response
- Good reliability
- High sensitivity
- Good spectrum characteristic

Typical Applications

- Camera automatic photometry
- Indoor ray control
- Industrial control
- Light control lamp
- Photoelectric control
- Annunciator
- Light control switch
- Electronic toy

Types and Specifications

Specification	Type	Max. Voltage	Max. power	Environmental temp.	Spectrum peak value
Φ5 series	GL5516	150	90	-30~+70	540
	GL5528	150	100	-30~+70	540
	GL5537-1	150	100	-30~+70	540
	GL5537-2	150	100	-30~+70	540
	GL5539	150	100	-30~+70	540
	GL5549	150	100	-30~+70	540

Specification	Light resistance (10Lux) (KΩ)	Dark resistance (MΩ)	γ_{10}^{100}	Response time (ms)		Illuminance resistance Fig. No.
				Increase	Decrease	
Φ5 series	5-10	0.5	0.5	30	30	2
	10-20	1	0.6	20	30	3
	20-30	2	0.6	20	30	4
	30-50	3	0.7	20	30	4
	50-100	5	0.8	20	30	5
	100-200	10	0.9	20	30	6

Test Conditions

Max. external voltage: Maximum voltage to be continuously given to component in the dark.

Dark resistance: Refer to the resistance ten seconds after the 10Lux light is shut up.

Max. power consumption: Maximum power at the environmental temperature 25°C.

Light resistance: Irradiated by 400-600Lux light for two hours, then test with 10Lux under standard light source A(as colour temperature 2856K).

γ value: Logarithm of the ratio of the standard resistance value under 10Lux and that under 100Lux.

$$\gamma = \frac{\text{Lg}(R_{10}/R_{100})}{\text{Lg}(100/10)} = \text{Lg}(R_{10}/R_{100})$$

R₁₀,R₁₀₀ are the resistances under 10Lux and 100Lux respectively.

Main Characteristics Curve and Dimensions

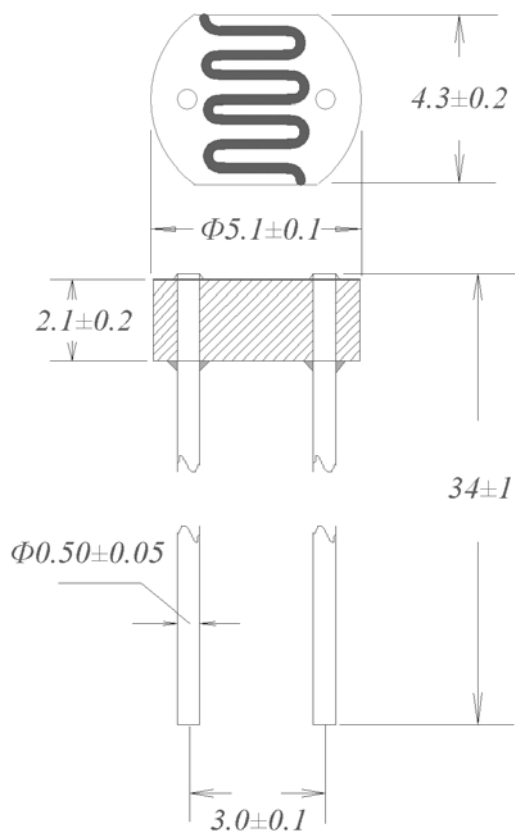

Specification unit: mm

Relative Resistance (%)

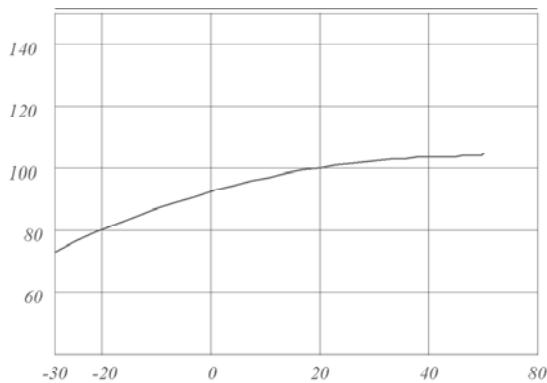

Temperature (°C)

Temperature-Property

Relative Response (%)

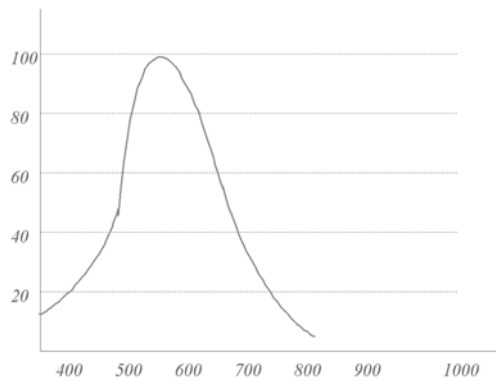

Wavelength λ (nm)

Spectrum Response Characteristic

Illuminance-Resistance Characteristics Curve

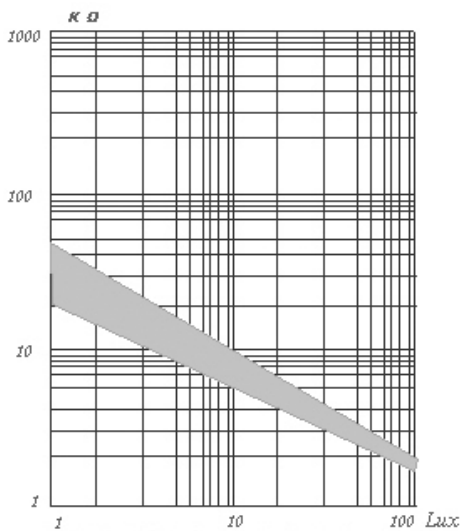

Fig. 1

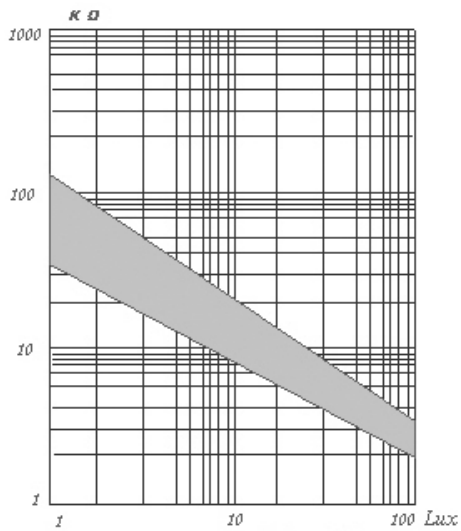

Fig.2

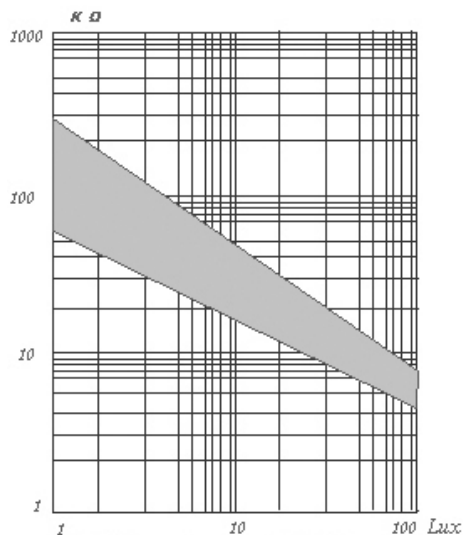

Fig. 3

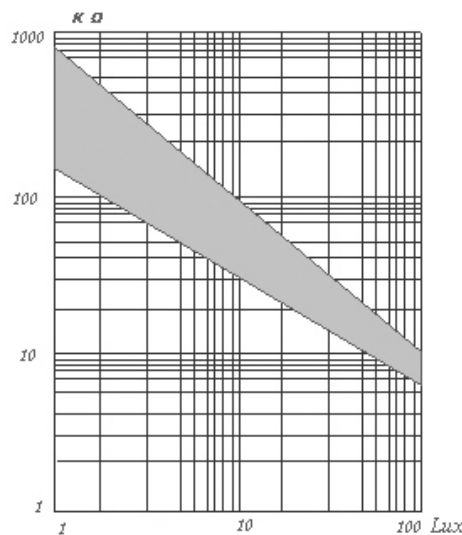

Fig. 4

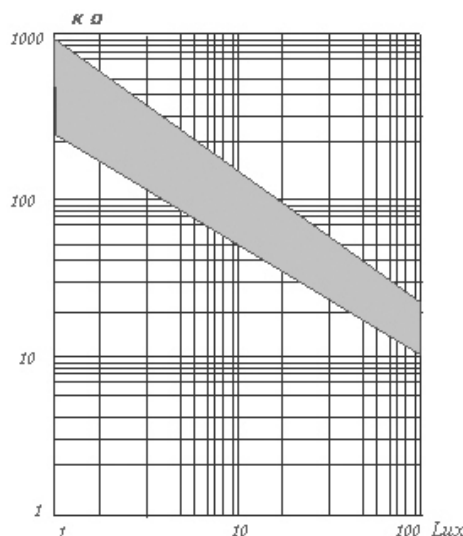

Fig.5

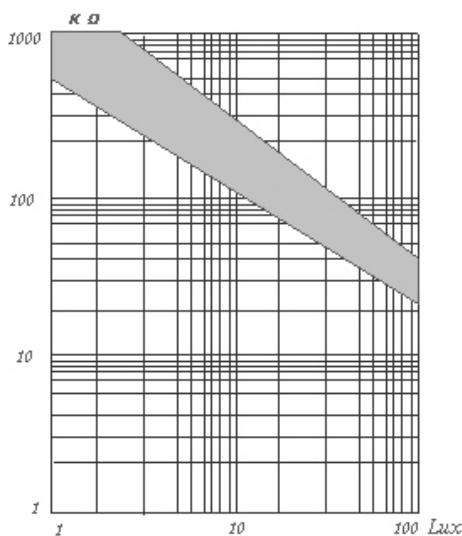

Fig. 6

Packing and Precaution

This product is packed with the environmental protection material, 100pcs per small package, 1000pcs per big package.

Avoid high temperature and humidity for storing.

Soldering should be completed in the shortest possible time.

It is recommended that the soldering should keep 4mm away from ceramic substrate.